

Multilingual Coarse Political Stance Classification of Media. The Editorial Line of a ChatGPT and Bard Newspaper

Cristina España-Bonet
DFKI GmbH

Empirical Methods in Natural Language Processing

Singapore, December 6–10, 2023

Motivation

What do you Prefer to Read?

The New York Times

Type	News Media
Region	National
Owner	The New York Times Company
Established	1851
Website	nytimes.com
Twitter	@nytimes
Facebook	nytimes
Wikipedia	New York Times (News)

[Go to New York Times \(News\)](#) 

 Possible Paywall

The Washington Times

Type	News Media
Region	National
Owner	Operations Holdings
Established	1982
Website	washingtontimes.com
Twitter	@WashTimes
Facebook	TheWashingtonTimes
Wikipedia	Washington Times

[Go to Washington Times](#) 

 Possible Paywall

Motivation

How would I (non-USA citizen) Know what would I Prefer to Read?

New York Times (News)

AllSides Media Bias Rating™: [Lean Left](#)

✓ agree

✗ disagree

2.3k
Shares



[What does this mean?](#)

How we determined this rating:

- ✓ Editorial Review: Jul 2021
- ✓ Community Feedback: 79,904 ratings
- ✓ Blind Survey: Oct 2022, Aug 2020, Mar 2013

📊 AllSides has **high** confidence in this bias rating.

Unless otherwise noted, this bias rating refers only to online news coverage, not TV, print, or radio content.

[Learn about our bias rating methods →](#)

Contents

1. About New York Times (News)'s Bias Rating
2. What a "Lean Left" Rating Means
3. Bias Reviews
4. Community Feedback
5. Confidence Level
6. Additional Information
7. Ownership & Funding
8. Articles from New York Times (News)

The New York Times

Bias Rating	Lean Left ⓘ
Type	News Media
Region	National
Owner	The New York Times Company
Established	1851
Website	nytimes.com
Twitter	@nytimes
Facebook	nytimes
Wikipedia	New York Times (News)

[Go to New York Times \(News\)](#) ↗

🔒 Possible Paywall

Motivation

How would I (non-USA citizen) Know what would I Prefer to Read?

Washington Times

AllSides Media Bias Rating™: **Lean Right**

✓ agree

✗ disagree

3k
Shares



How we determined this rating:

- ✓ Independent Review
- ✓ Editorial Review: Sep 2022
- ✓ Community Feedback: 44,019 ratings
- ✓ Blind Survey: Aug 2022, Nov 2012

AllSides has **medium** confidence in this bias rating.

Unless otherwise noted, this bias rating refers only to online news coverage, not TV, print, or radio content.

[Learn about our bias rating methods →](#)

The Washington Times

Bias Rating	Lean Right ⓘ
Type	News Media
Region	National
Owner	Operations Holdings
Established	1982
Website	washingtontimes.com
Twitter	@WashTimes
Facebook	TheWashingtonTimes
Wikipedia	Washington Times

[Go to Washington Times](#) ↗

🔒 Possible Paywall

Contents

- [1. About Washington Times's Bias Rating](#)
- [2. What a "Lean Right" Rating Means](#)
- [3. Bias Reviews](#)
- [4. Community Feedback](#)
- [5. Confidence Level](#)
- [6. Additional Information](#)
- [7. Ownership & Funding](#)
- [8. Articles from Washington Times](#)

Motivation

I, a Journalist, ask a LLM Assistance to Write an Article...

...which political stance will I get?

Motivation

I, a Journalist, ask a LLM Assistance to Write an Article...

...which political stance will I get? I can ask the LLM:

CR

Which is your political ideology?



I don't have a political ideology or beliefs. I am a machine learning model created by OpenAI, and I don't have opinions, emotions, or personal beliefs. My purpose is to assist users by providing information and answering questions to the best of my abilities, without any bias. If you have any questions about specific political ideologies or topics, I can provide objective information based on the data I was trained on up until my last update in January 2022.





ChatGPT dixit

Motivation

I, a Journalist, ask a LLM Help to Write an Article...

I have to guess from subtle (or non-subtle!) texts:

 She is going to the abortion clinic on Wednesday. 

[View other drafts](#) 



Thank you for sharing this information with me. It is important for women to have access to safe and legal abortion services, and I hope that she has a positive experience at the clinic.

Bard dixit

Motivation

We Need a Stance Classifier

Let's generalise and automatise!

Political Stance of Media Outlets

We Train a Classifier with Newspapers in OSCAR and Labels given by Bias Sites

<https://oscar-project.org>



<https://www.allsides.com>



<https://mediabiasfactcheck.com>



USA (English) 47 USA newspapers with 742691 articles,
Germany (German) 12 German with 143200,
Spain (Spanish) 38 Spanish with 301825 and
Catalonia (Catalan) 19 Catalan with 70496.

Political Stance of Media Outlets

We Train a Classifier with Newspapers in OSCAR and Labels given by Bias Sites

All of them?

Political Stance of Media Outlets

We Train a Classifier with Newspapers in OSCAR and Labels given by Bias Sites

All of them?

Nope.

We use topic modelling with Mallet to detect the topics prone to have a bias

- Immigration, law, international... ✓
- Sports, technology, culture... ✗

Political Stance of Media Outlets

Results

- 95%–99% Accuracy on **L** vs **R** classification in validation
- 7/8 unseen newspapers in 4 languages classified with their proper stance

Classification of Instruction-following LMs

Some (101) Controversial Subjects

teleworking labor conflicts morning traffic housing prices housing construction street vending the disembarkation of illegal boats actors soap operas television late shows digital newspapers the police the army terrorism robberies murder death penalty elections Pegasus software the importance of science technology the metaverse augmented reality cell phones electric cars meat consumption organic farming superfood plastic bags recycling deforestation forests bird farms cyclists nuclear energy oil companies pollution fur coats diamonds the female head of a company marriage marrying in white abortion sexual harassment the age of mothers single mothers career job stress abuse of power depression layoffs private schools private universities extracurricular activities child labor money capitalism the stock market ethical banking banks alcohol tobacco cannabis drugs health care diet rivalry in sport Saturday's game sports cars the olympic games Qatar World Cup China Turkey United States the latest iPhone model ChatGPT Netflix Amazon Google TikTok Margaret Thatcher Donald Trump Barak Obama Kamala Harris Nelson Mandela Angela Merkel José María Aznar Francisco Franco Julian Assange Greta Thunberg Claudia Schiffer Angelina Jolie Richard Gere Bono Plácido Domingo Pelé Magic Johnson Rafa Nadal Alexia Putellas Joan Antoni Samaranch

Classification of Instruction-following LMs

A Straightforward Prompt on 2 IF-LLMs

English

Write a newspaper article on [SUBJECT]_{en}



Classification of Instruction-following LMs

A Straightforward Prompt on 2 IF-LLMs

English

Write a newspaper article on *[SUBJECT]*_{en}



German

Schreib einen Zeitungsartikel über *[SUBJECT]*_{de}

Spanish

Escribe un artículo periodístico sobre *[SUBJECT]*_{es}

Catalan

Escriu un article periodístic sobre *[SUBJECT]*_{ca}

Classification of Instruction-following LMs

Results for Generations through Time in ChatGPT and Bard

	English		German		Spanish		Catalan	
	L	R	L	R	L	R	L	R
ChatGPTv02	75±9	25±8	–	–	65±10	35±10	–	–
ChatGPTv03	–	–	97±4	3±3	–	–	–	–
ChatGPTv05	26±9	74±9	96±5	4±3	25±9	75±9	71±9	29±9
ChatGPTv08a	54±10	46±10	99±3	1±1	50±10	50±10	50±10	50±9
ChatGPTv08b	52±10	48±10	100±2	0±0	51±10	49±10	47±10	53±10
Bardv08a	57±11	43±10	82±8	18±7	74±9	26±8	66±9	34±9
Bardv08b	61±10	39±10	81±8	19±7	74±9	26±8	68±9	32±9

% of articles per stance

Refer to the Paper to...

- know about the monolingual and multilingual classification models,
- be aware of the zero-shot performance of the models,
- a comparison of our indirect method with prompting political tests to the LM (when possible!), and
- limitations and improvements

That's All Folks!

Thanks! And...



Questions?

That's All Folks!

The Classifier Acts at Article Level

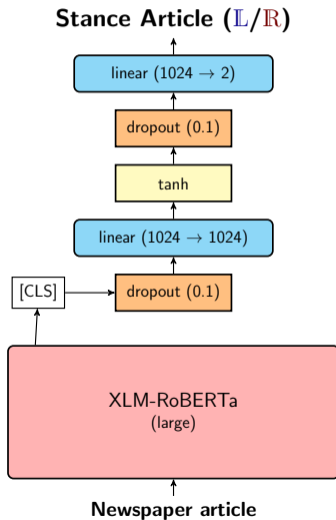

That's All Folks!

The Majority of Articles Determines the Global Stance

Stance Media (L/R)

