

Papirosaurus

Created and diagramed by Marc Vigo
June 2013

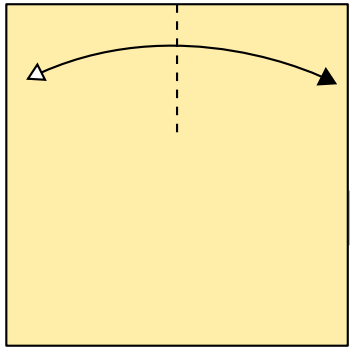

1

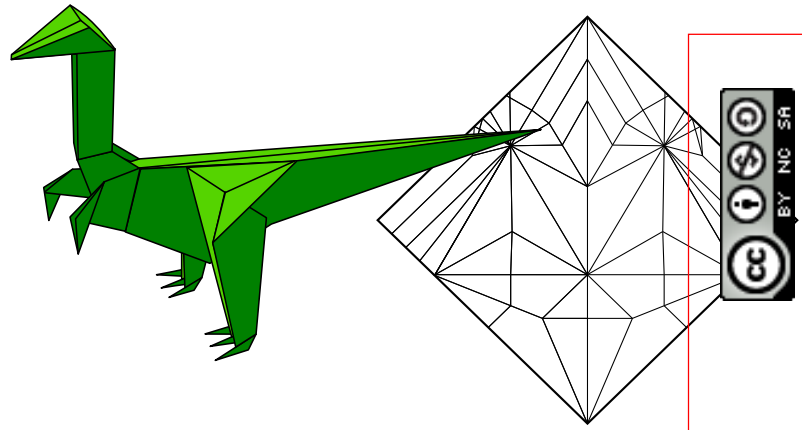
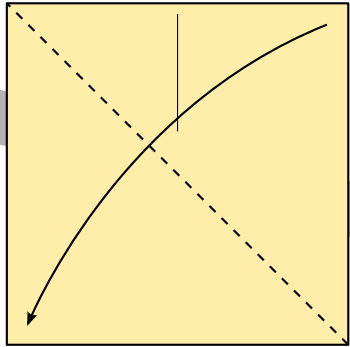

2

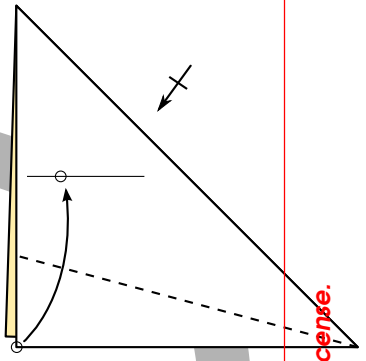

3 Bring corner to crease

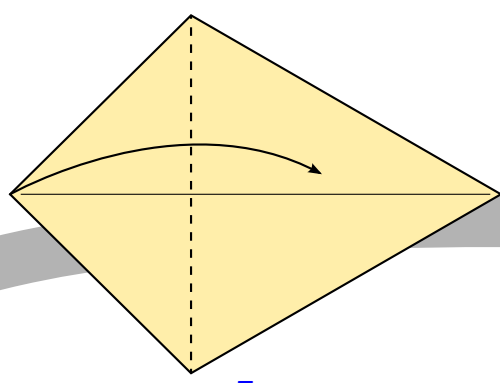

5

45°

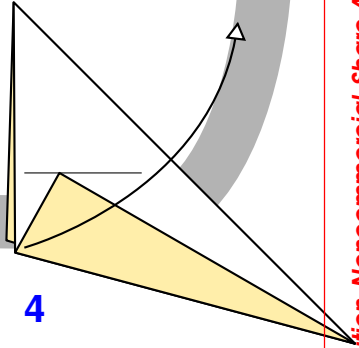

4

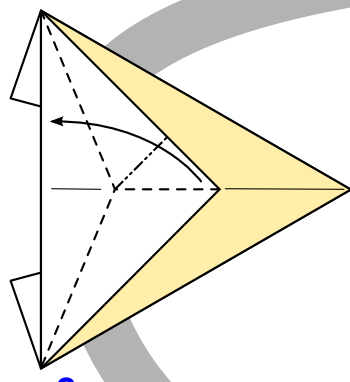

6

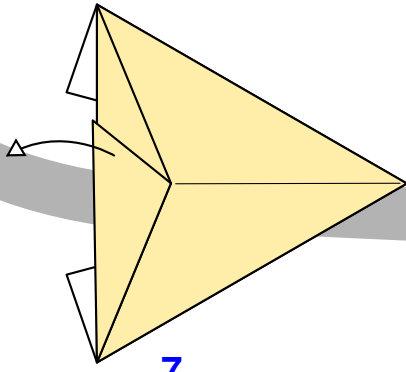

7

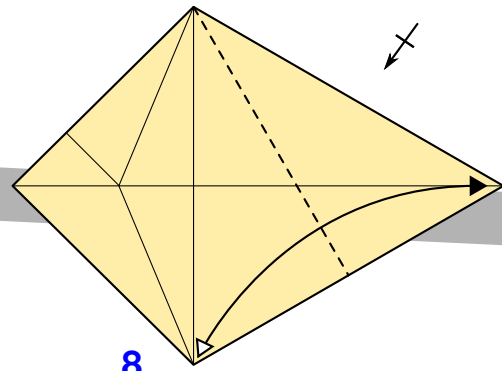

8

This work is licensed under the Creative Commons Attribution-NonCommercial-Share Alike 2.5 License.
To view a copy of this license, visit <http://creativecommons.org/licenses/by-nc-sa/2.5/>
or send a letter to Creative Commons, 543 Howard Street, 5th Floor, San Francisco, California, 94105, USA.



This work is licensed under the Creative Commons Attribution-NonCommercial-Share Alike 2.5 License. To view a copy of this license, visit <http://creativecommons.org/licenses/by-nc-sa/2.5/> or send a letter to Creative Commons, 543 Howard Street, 5th Floor, San Francisco, California, 94105, USA.

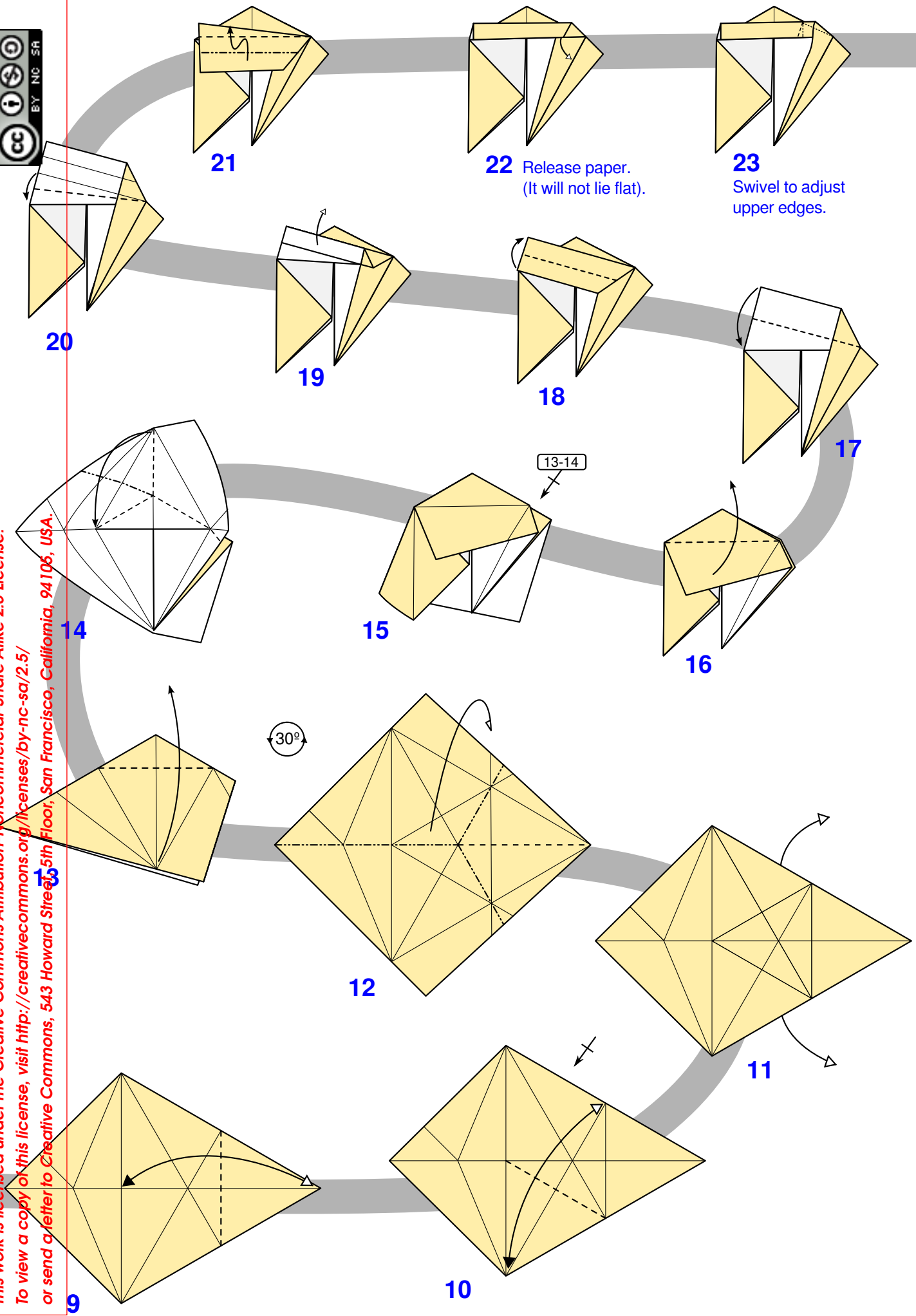



This work is licensed under the Creative Commons Attribution-NonCommercial-Share Alike 2.5 License. To view a copy of this license, visit <http://creativecommons.org/licenses/by-nc-sa/2.5/> or send a letter to Creative Commons, 543 Howard Street, 5th Floor, San Francisco, California, 94105, USA.

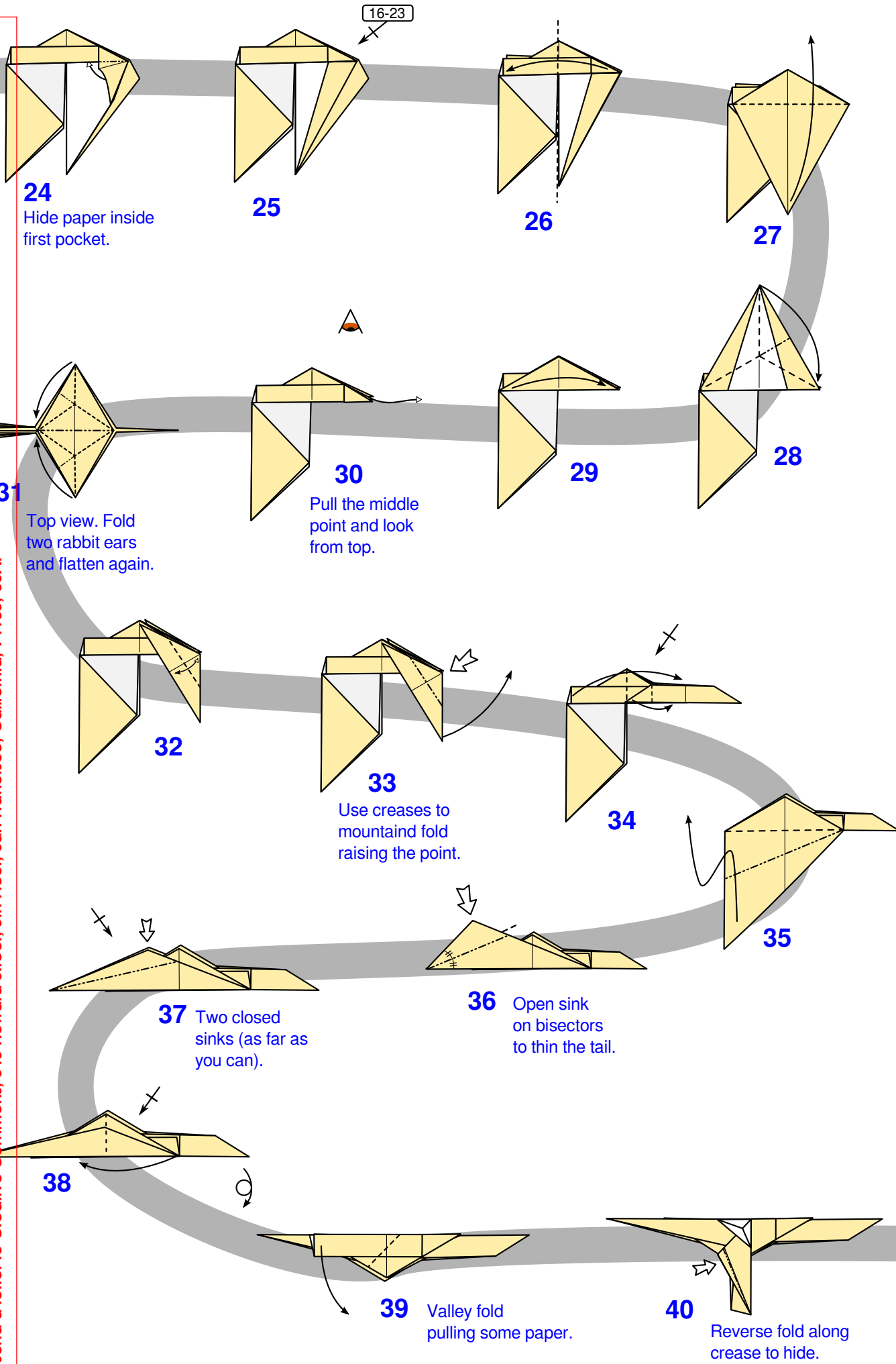

24 Hide paper inside first pocket.

25

26

27

31 Top view. Fold two rabbit ears and flatten again.

30 Pull the middle point and look from top.

29

28

32

33 Use creases to mountain fold raising the point.

34

35

37 Two closed sinks (as far as you can).

36 Open sink on bisectors to thin the tail.

38

39 Valley fold pulling some paper.

40 Reverse fold along crease to hide.

Reverse fold along crease to hide.



This work is licensed under the Creative Commons Attribution-NonCommercial-Share Alike 2.5 License. To view a copy of this license, visit <http://creativecommons.org/licenses/by-nc-sa/2.5/> or send a letter to Creative Commons, 543 Howard Street, 5th Floor, San Francisco, California, 94105, USA.

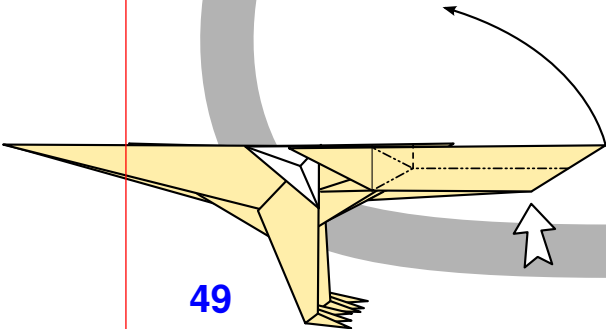
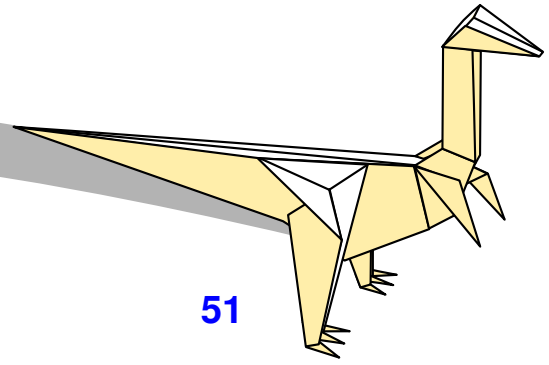
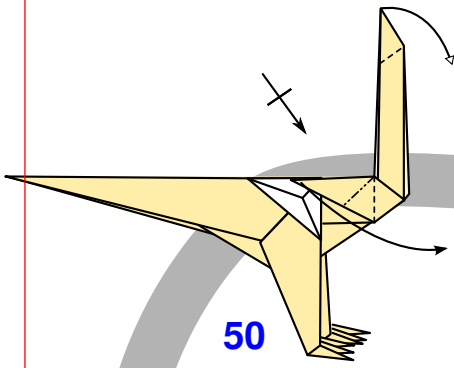

Double rabbit ear while sinking where indicated.

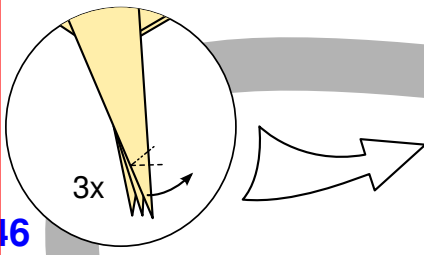
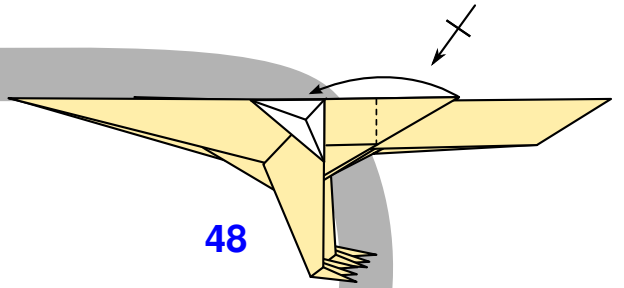

Crimp to form toes.

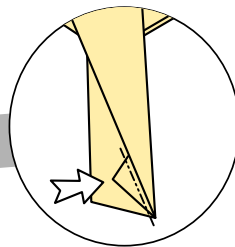
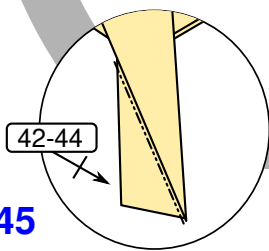
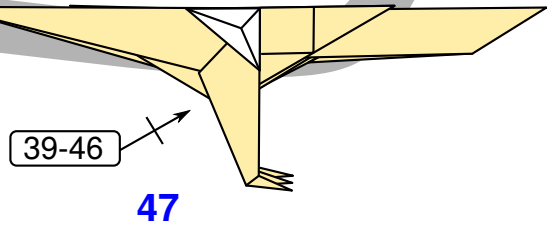

And again

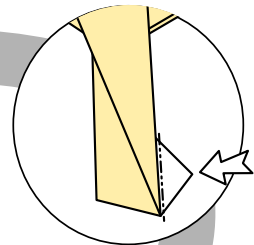

Again.

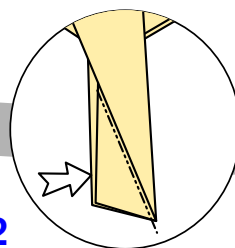
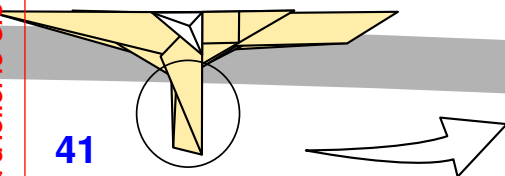

Reverse fold along adjusting to edge.